

# DISC

---

LIGHT & OUTDOOR HEATER

PIETBOON by HEATSAIL

*No better background scenery for a nice long  
conversation than a sultry summer night.*

*Why don't we just make it a  
little warmer and lighter outside,  
so those summer nights can last forever.*



## DISC

---

Wanting to spend more time outdoors throughout the seasons requires solutions to enable that desire. The DISC heating and lighting system is an innovative design object that increases the comfort of outdoor living and extends the outdoor season. Powered by electricity, it is more efficient and more user-friendly than traditional gas-powered heaters. The elegant design of this future-proof solution allows it to blend harmoniously into its surroundings. The DISC is a collaboration that perfectly blends the design expertise of Studio Piet Boon with the technical innovators at Heatsail.

3

  
**archiproducts**  
DESIGN AWARDS  
—  
WINNER 2020

DISC

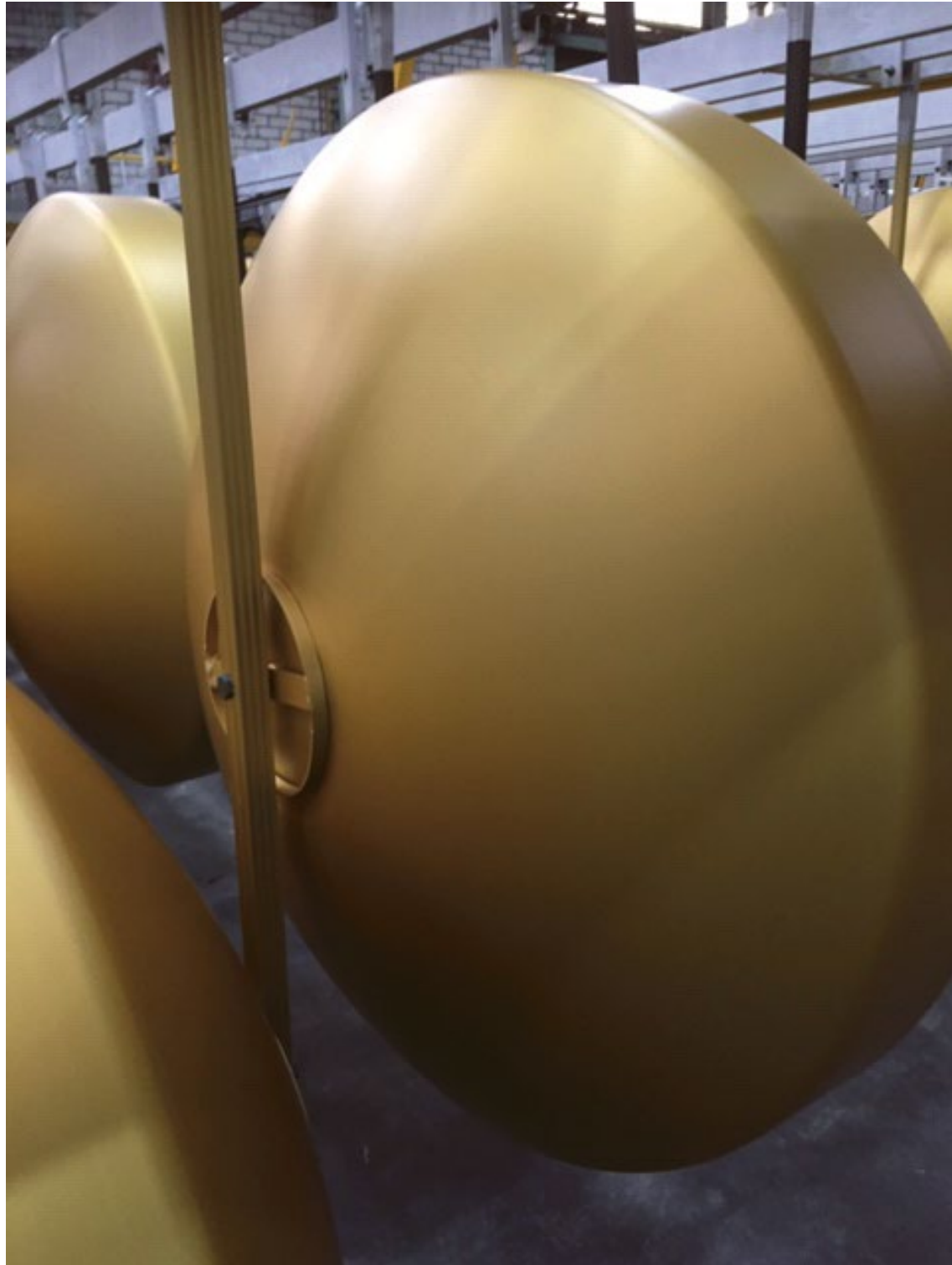

## HEATSAIL

---

Heatsail is a Belgian company established in 2012 that has redefined the luxury lighting, heating and cooling space. They develop unique technical outdoor products to create long-lasting experiences by extending the finest moments of a beautiful day.



## STUDIO PIET BOON

---

Studio Piet Boon is a globally operating architecture, interior and product design studio recognized for crafting the perfect balance between functionality, aesthetics and individuality. The multidisciplinary team designs acclaimed private homes, residential & corporate developments, hospitality experiences and an extensive range of products. Studio Piet Boon was founded in 1983 by Piet Boon and Karin Meyn in Oostzaan, The Netherlands.



## PIET BOON PRODUCTS

---

Complementing the Studio Piet Boon brand and design, Studio Piet Boon seeks partnerships with like-minded brands and companies that are passionate about delivering outstanding quality.

These partnerships result in a wide range of carefully designed products for all indoor and outdoor living spaces that seamlessly complement each other. Refinement, functionality and timelessness characterize the authentic and distinctive design philosophy of Studio Piet Boon. The love for rich and natural materials, generous proportions, typical forms and eye for extraordinary details can be found in every piece Studio Piet Boon designs. The interplay of products underline the Studio Piet Boon experience as a whole, or separate elements can add a part of the Piet Boon signature to each space.

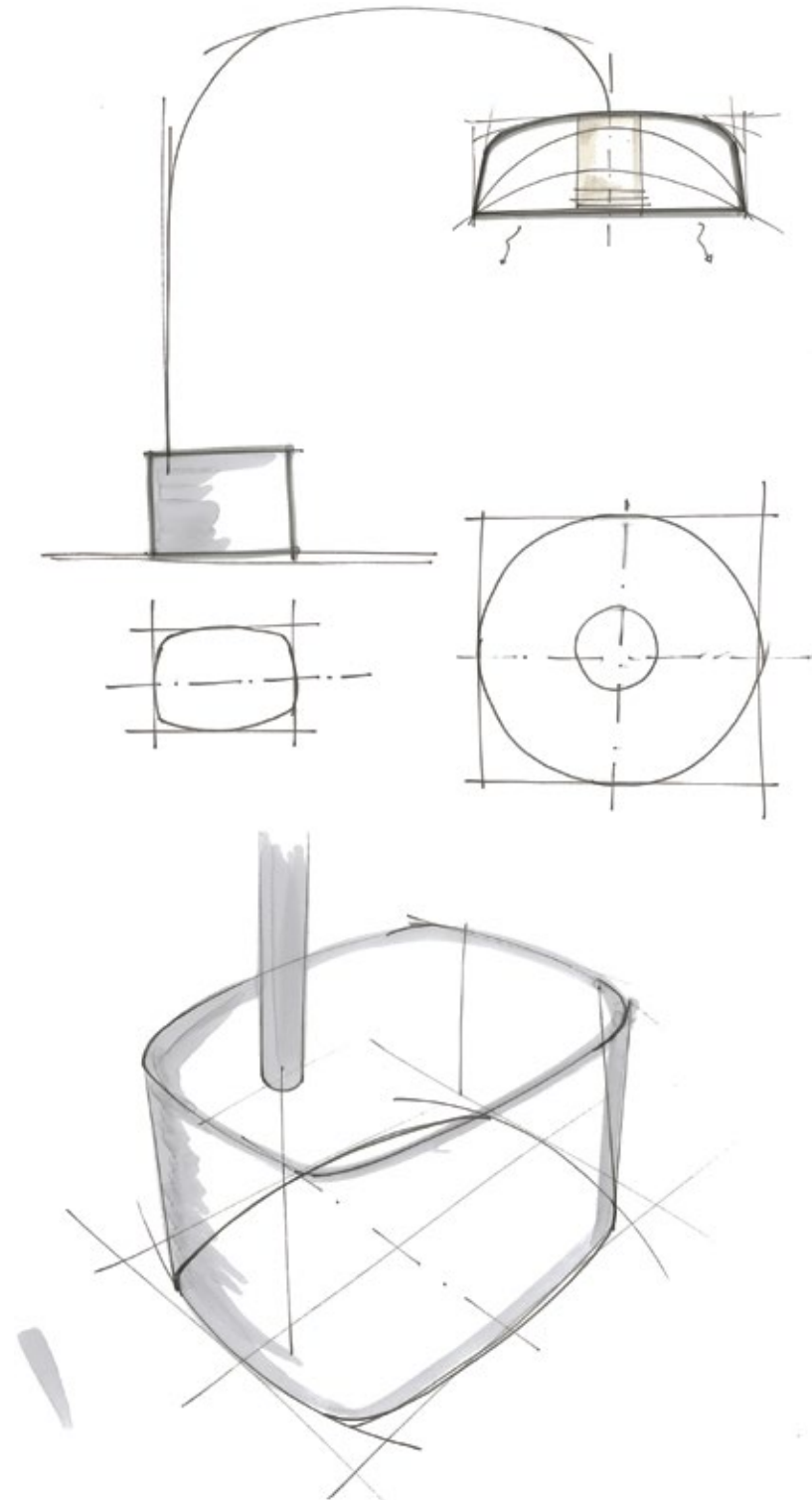

## CONCEPT

The DISC should be a daily life companion, functional, easy to use and a beautiful object that can harmoniously fit with other Piet Boon outdoor products. Studio Piet Boon defined the shapes of the three main components; the base, the bow and the hood, following a specific aesthetic ratio curve that is often reflect in the Piet Boon designs. Combining these aesthetic choices with the technical elements for optimal heating and lighting has resulted in a durable and functional design object that can be exposed to all kinds of weather.

PIETBOON

# Technical information

## Low maintenance

By using highly efficient and durable ceramic heating elements and the best materials, the DISC is virtually maintenance free.



## Rust-free & weatherproof

The DISC is made of high quality materials such as aluminum and stainless steel, making it suitable for outdoor use.



## Patented design

The unique patented design makes the DISC PT an absolute eyecatcher, exuding luxury, elegance and exclusivity.



## Low energy usage, zero CO2 emission

The DISC uses less energy than the traditional gas heaters and generates up to 25% more heat with an energy consumption of only 3.22 kWh.



## Reach & glow

Up to 5 meters reach. Comfortable warmth without red glow.



## Dimensions

Hood diameter	100 cm
	3' 3.4"
Hood height	32 cm
	1' 0.6"
Base	63 x 47 x 32 cm
	2' 0.8" x 1' 6.5" x 1' 0.6"

## Technical specifications

Consumption	3.22 kWh
Heat	3100 Watt
Light	120 Watt

## Remote control

Independently controlled heat (two settings) and light.

## Wheels

De DISC is equipped with 4 wheels.

## Colors

Colors are indicative.

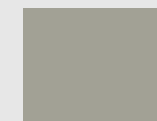

Dust

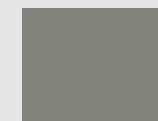

Pebble

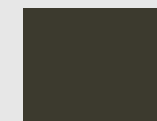

Mud

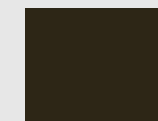

Coal

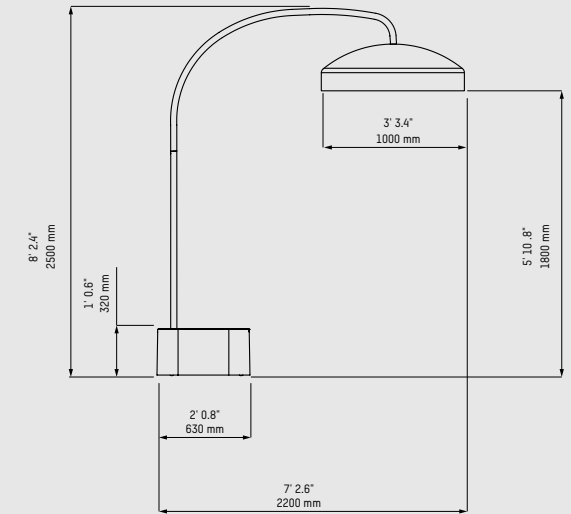





# DISC pendant

## Dimensions

Width	100 cm 3' 3.4"
Hood height	32 cm 1' 0.6"
Height to ground	180 - 195 cm 5' 11" - 6' 5"
Ceiling height	242 - 337 cm 7' 11" - 11' 1"
Weight	17 kg 38 lb

## Technical specifications

Consumption	3.22 kWh
Heat	3100 Watt
Light	120 Watt

## Remote control

Independently controlled heat (two settings) and light.

## Colors

Colors are indicative.



Dust

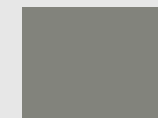

Pebble



Mud

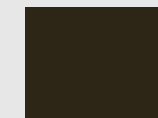

Coal

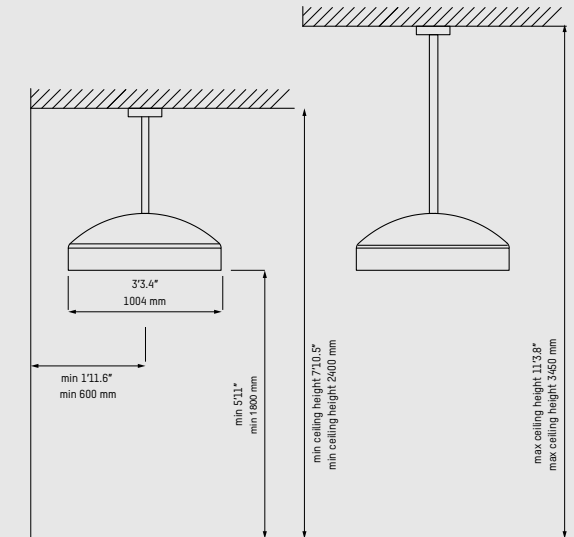

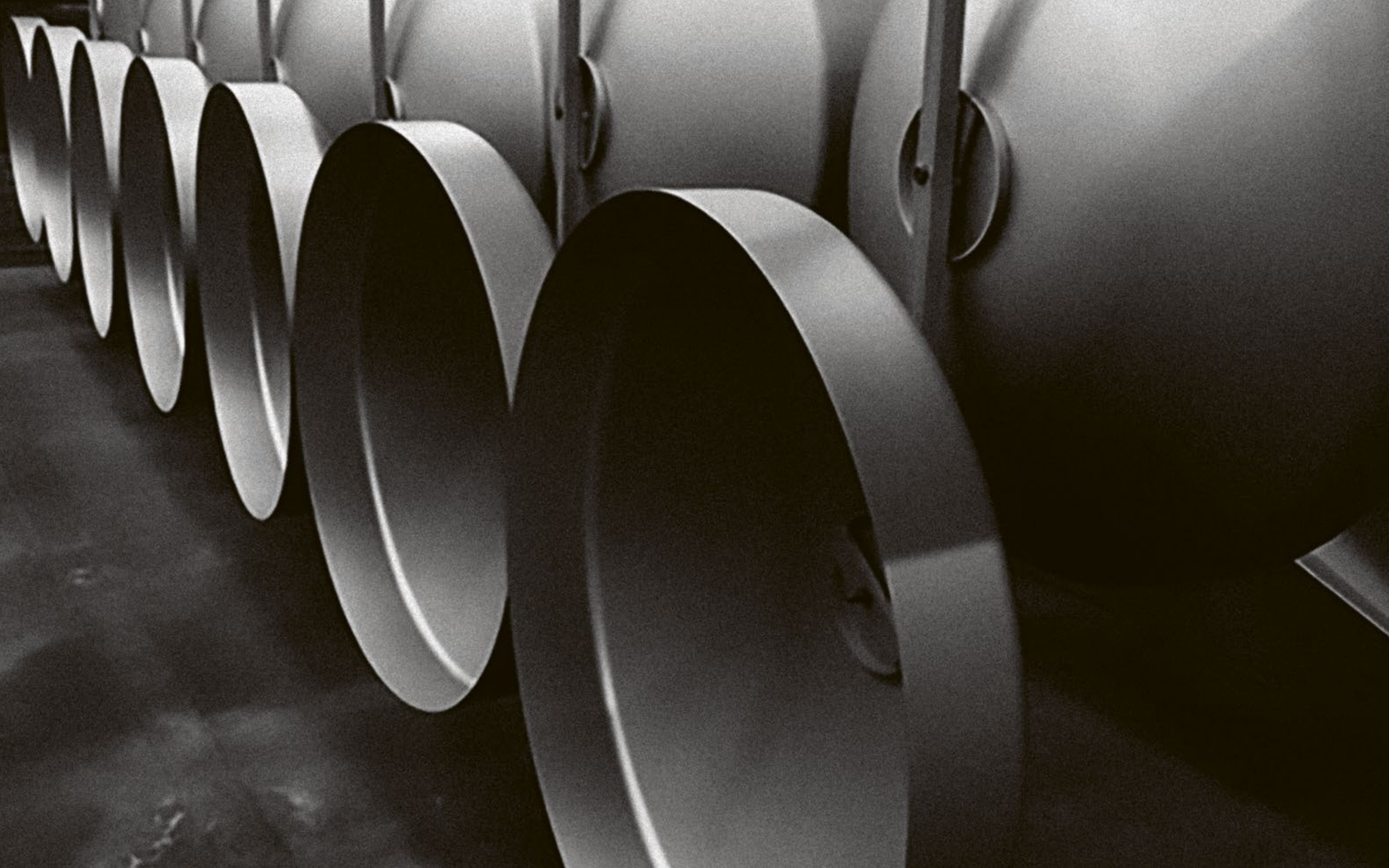

*Extend your great moments*

